

# DSR IT 19" COLLOCATION SERVER CABINETS

## DESCRIPTION

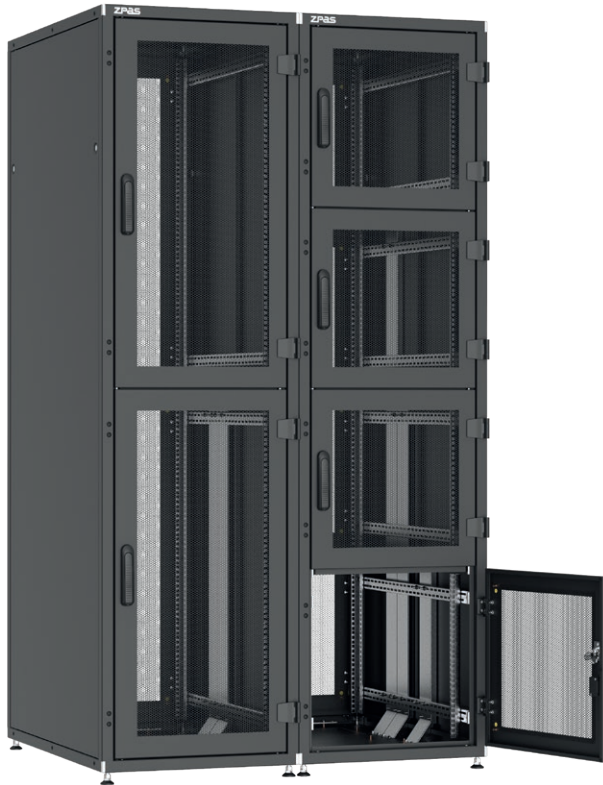

DSR IT cabinets 47 U, 600 x 1000 mm



DSR IT 47 U, 800 x 1200 mm

## CHARACTERISTIC

- The interior of the cabinet is divided by horizontal partitions for two or four compartments. Each compartment is equipped with: an independent 19" rack, cable trays routed on both sides of the cabinet, a door.
- A different key code for each compartment of the cabinet.
- Cable entry from the bottom or from the top.
- Cable openings in the top and bottom plates with knock-out blanking plates.
- U-marking on the mounting profiles.
- Maximum opening angle for front and rear door – 270°.
- Possibility to change door opening's direction.
- Possibility to put the cabinet directly on the floor (no protruding elements under the cabinet).
- Adaptation for buying the cabinets in row and Data Box creation (cold/hot aisle).

## SCOPE OF DELIVERY

- Bolted frame (bottom plate, top plate, four posts).
- One or three horizontal partitions (depending on the cabinet's configuration).
- Perforated metal front and rear doors (80% perforation clearance) for each compartment of the cabinet.
- Side panels or partitions (depending on the cabinet's configuration).
- Two pairs of 19" mounting profiles type STANDARD for each compartment of the cabinet.
- Cable channels (depending on the cabinet's configuration).
- Earthing bar.
- Earthing conductors for doors and side panels.
- Four levelling feet.

## TECHNICAL DATA

### Material

Frame, side panels, partitions, doors, mounting profiles, C-profiles, cable trays

- sheet steel.

Outriggers (in 800 mm wide cabinets)

- zamak casting.

### Protection degree

IP 20 in accordance with EN 60529.

### Surface finishing

Frame, side panels, doors, partitions - powder paint, light grey (RAL 7035) or black (RAL 9005).

Mounting profiles, C-profiles, cable trays - Al-Zn coated.

### Maximum load capacity

1500 kg

## WYPOSAŻENIE DODATKOWE od str. 67

- **Plinth** page 68
- **Blanking and cable entry plates** page 83
- **Power strips** page 104
- **Shelves** page 72
- **Mounting guides** page 79

COLLOCATION SERVER CABINETS **DSR IT 19"**

DESCRIPTION



**DSR IT**  
47 U, 800 x 1000 mm,  
2 compartments 23 U,  
cable trays  
routed from below

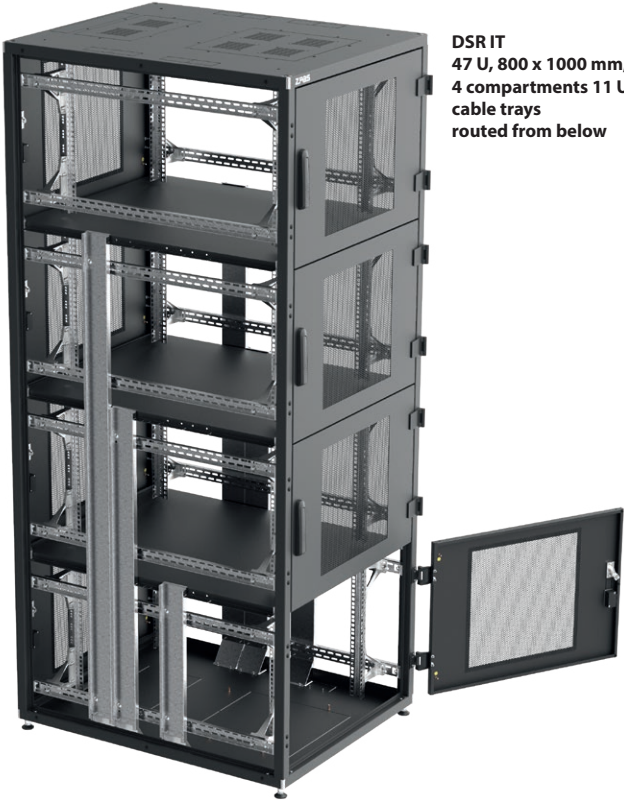

**DSR IT**  
47 U, 800 x 1000 mm,  
4 compartments 11 U,  
cable trays  
routed from below



**DSR IT 600 x 1200 mm, top plate**

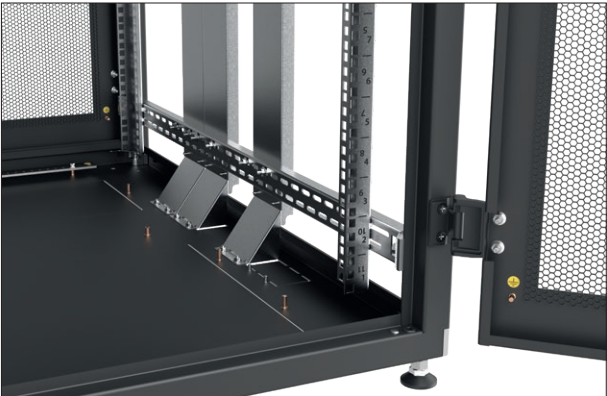

**DSR IT 600 x 1200 mm, bottom plate**

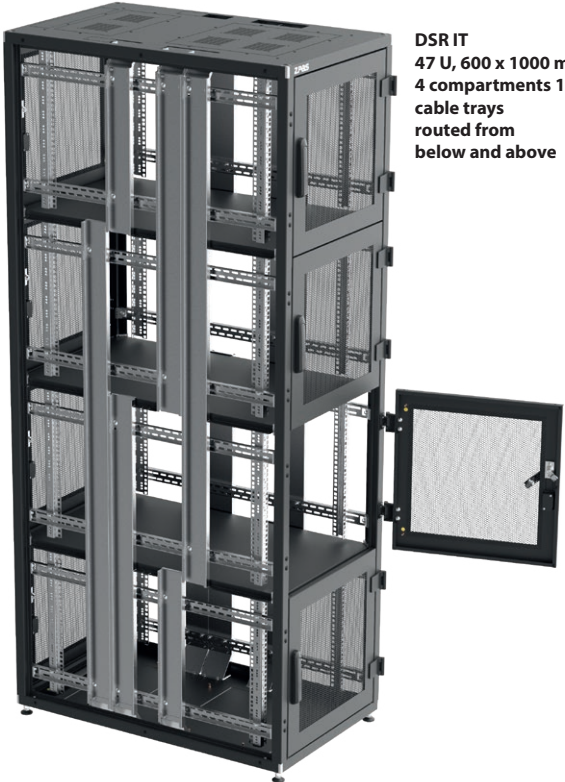

**DSR IT**  
47 U, 600 x 1000 mm,  
4 compartments 11 U,  
cable trays  
routed from  
below and above

# DSR IT 19" COLLOCATION SERVER CABINETS

## DESIGN

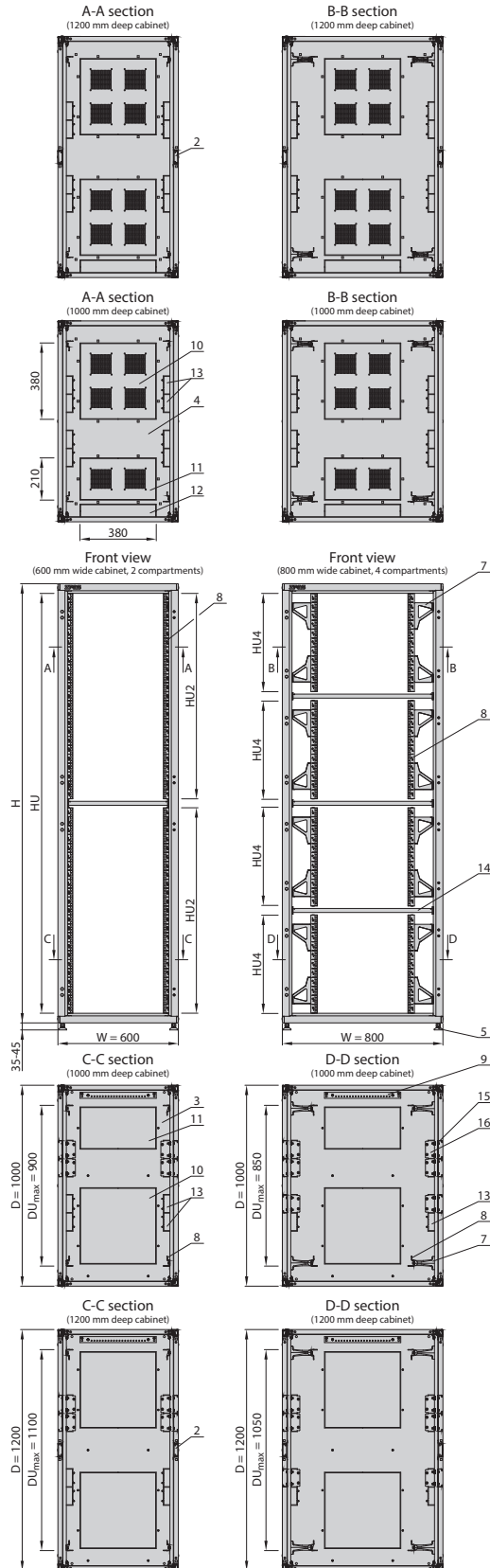

## DESIGN

1. Frame's post
2. Frame's middle post
3. Frame's bottom plate
4. Frame's top plate
5. Adjustable feet
6. C-profile for 15 mm deep mounting profiles
7. Outrigger
8. 19" mounting profile, type STANDARD, 15 mm deep
9. Earthing bar
10. Knock-out blanking plate 380 x 380 mm
11. Knock-out blanking plate 380 x 210 mm
12. Knock-out blanking plate 380 x 71 mm
13. Knock-out blanking plate 87 x 44 mm
14. Partition
15. Cable tray 90 x 20.5 mm
16. Cable cover

### Note:

The cabinets in the drawing are shown without any panels or doors.

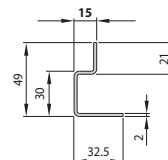
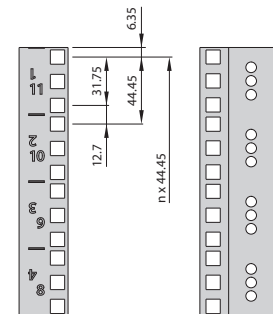
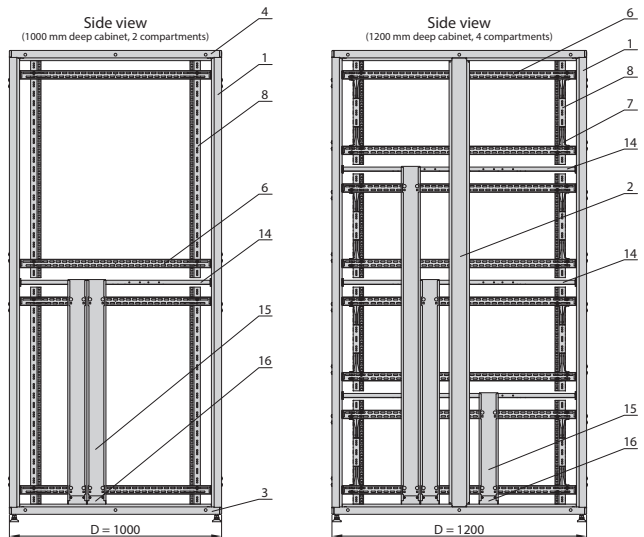

19" mounting profile  
type STANDARD,  
15 mm deep

COLLOCATION SERVER CABINETS **DSR IT 19"**

CONFIGURATOR

REFERENCE CHART

Width W [mm]	Depth D [mm]	Reference number	
600	1000	<b>426010</b>	<b>476010</b>
	1200	<b>426012</b>	<b>476012</b>
800	1000	<b>428010</b>	<b>478010</b>
	1200	<b>428012</b>	<b>478012</b>
<b>Total frame height H [mm]</b>		1963	2186
<b>Usable frame height HU [U = 44.45 mm]</b>		42 U	47 U
<b>Usable compartments height</b>	<b>2 compartments: 2 x HU2</b>	2 x 20 U	2 x 23 U
	<b>4 compartments: 4 x HU4</b>	4 x 10 U	4 x 11 U

CATALOGUE NUMBER OF DSR IT CABINET

**W-DIT-XXXXXX-44XX-XX-XXX**

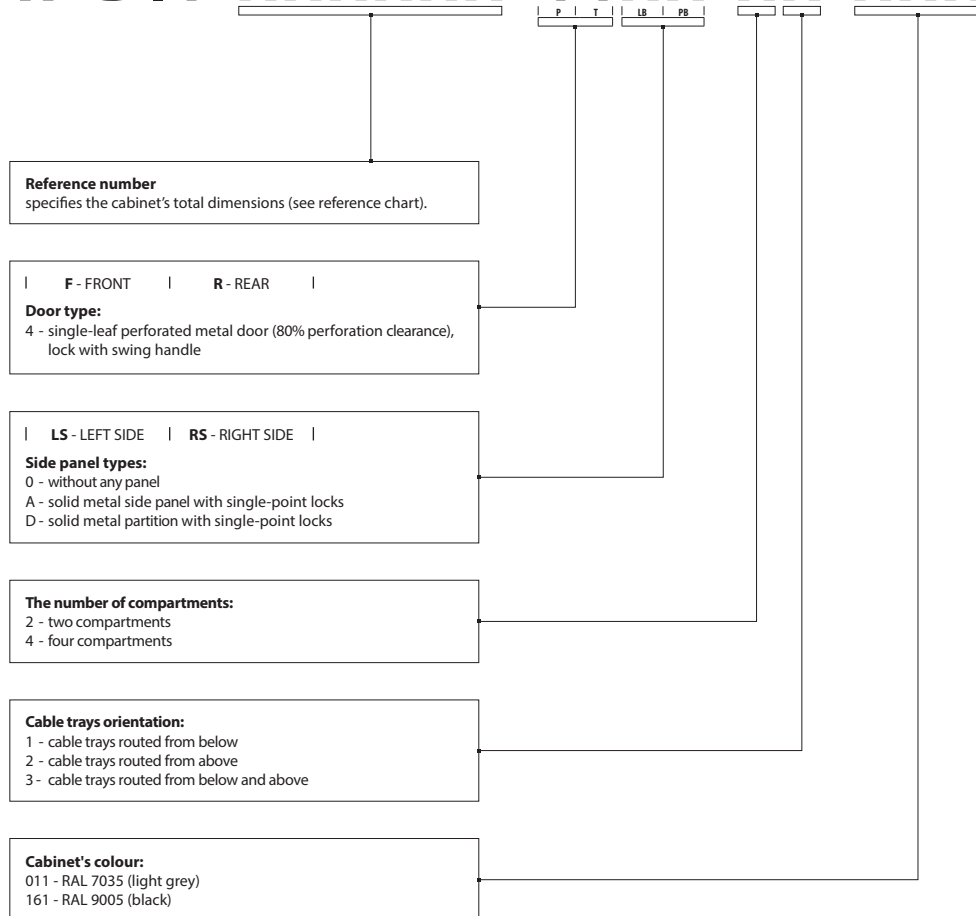



# SZB/DSR IT 19" SERVER CABINETS

COLD AISLE INSTALLATIONS

## Cold aisle installation

The **SZB IT Data Box** solution physically separates the air distributed by air conditioners and the hot air generated by operating equipment.

**SZB IT Data Box** optimises the usability of the data centre infrastructure.

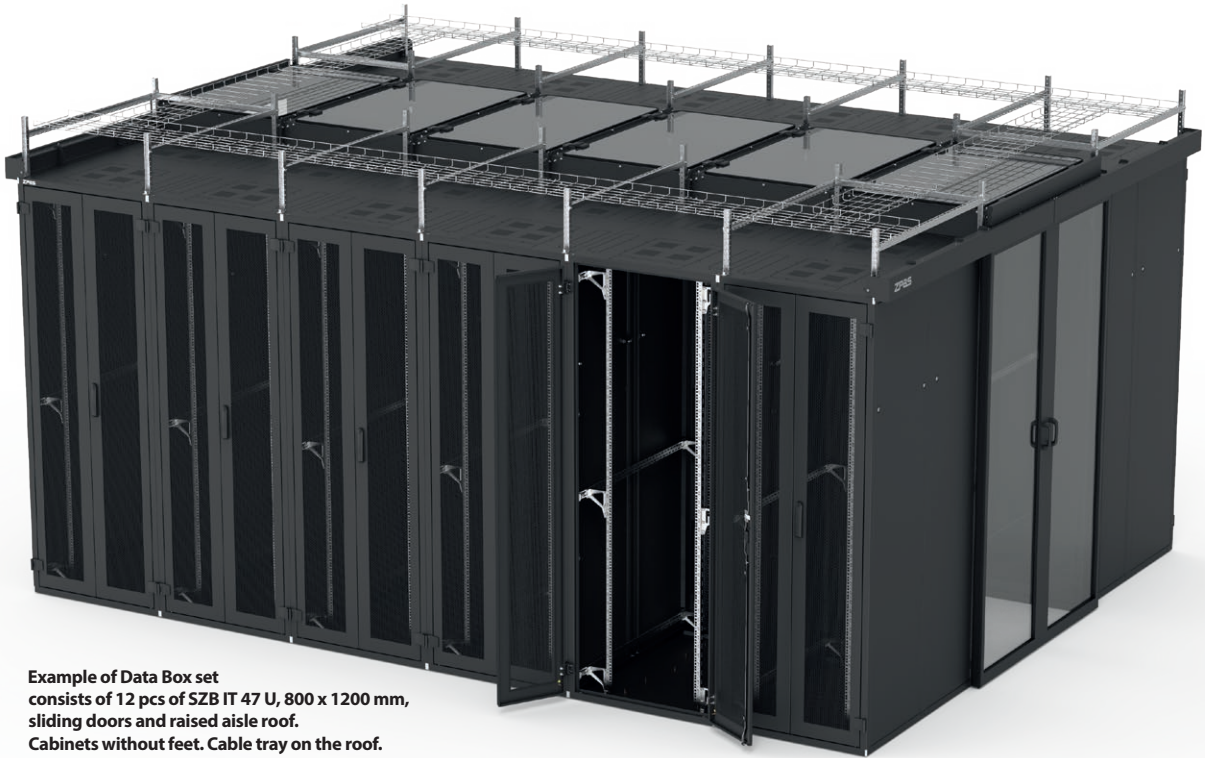

Example of Data Box set consists of 12 pcs of SZB IT 47 U, 800 x 1200 mm, sliding doors and raised aisle roof. Cabinets without feet. Cable tray on the roof.



Example of Data Box set consists of:  
 4 pcs of SZB IT 42 U, 800 x 1000 mm,  
 2 pcs of DSR IT 42 U, 800 x 1000 mm with 2 compartments,  
 2 pcs of DSR IT 42 U, 800 x 1000 mm with 4 compartments,  
 sliding doors, flat aisle roof.  
 Cabinets on 100 mm plinth.

SERVER CABINETS **SZB/DSR IT 19"**

COLD AISLE INSTALLATIONS

**Cold aisle sliding door**

Manual sliding glass doors without a lock. Opened along the entire width of the aisle. Supplied with a roof masking panel and cabinet side panels.  
Designed for cold aisle **1200 mm** wide.

**Material**

Aluminium profiles; safety glass; sheet steel powder painted in light grey (RAL 7035) or black (RAL 9005).

**Scope of delivery**

Two sliding door leaves with rails, runners and self-closer, two or four cabinet side panels (depending on the depth of the cabinets), aisle roof masking panel, fixing accessories.



**W-8848-01-03-161**  
Cold aisle sliding door for Data Box 47 U, 1200 mm, without feet or plinth, with raised roof



**W-8848-01-06-161**  
Cold aisle sliding door for Data Box 42 U, 1000 mm, with plinth and flat roof



**W-8848-01-06-161**  
Cold aisle sliding door for Data Box 47 U, 1200 mm, with feet and raised roof

For Data Box cabinets¹		Catalogue number			
		Sliding door for aisle with raised roof		Sliding door for aisle with flat roof	
height	depth	RAL 7035	RAL 9005	RAL 7035	RAL 9005
42 U without feet or plinth	1000	W-8848-20-01-011	W-8848-20-01-161	W-8848-30-01-011	W-8848-30-01-161
	1200	W-8848-01-01-011	W-8848-01-01-161	W-8848-45-01-011	W-8848-45-01-161
47 U without feet or plinth	1000	W-8848-20-03-011	W-8848-20-03-161	W-8848-30-03-011	W-8848-30-03-161
	1200	W-8848-01-03-011	W-8848-01-03-161	W-8848-45-03-011	W-8848-45-03-161
42 U with feet	1000	W-8848-20-04-011	W-8848-20-04-161	W-8848-30-04-011	W-8848-30-04-161
	1200	W-8848-01-04-011	W-8848-01-04-161	W-8848-45-04-011	W-8848-45-04-161
47 U with feet	1000	W-8848-20-06-011	W-8848-20-06-161	W-8848-30-06-011	W-8848-30-06-161
	1200	W-8848-01-06-011	W-8848-01-06-161	W-8848-45-06-011	W-8848-45-06-161
42 U with plinth	1000	W-8848-20-07-011	W-8848-20-07-161	W-8848-30-07-011	W-8848-30-07-161
	1200	W-8848-01-07-011	W-8848-01-07-161	W-8848-45-07-011	W-8848-45-07-161
47 U with plinth	1000	W-8848-20-09-011	W-8848-20-09-161	W-8848-30-09-011	W-8848-30-09-161
	1200	W-8848-01-09-011	W-8848-01-09-161	W-8848-45-09-011	W-8848-45-09-161

Package: 1 set

# SZB/DSR IT 19" SERVER CABINETS

COLD AISLE INSTALLATIONS

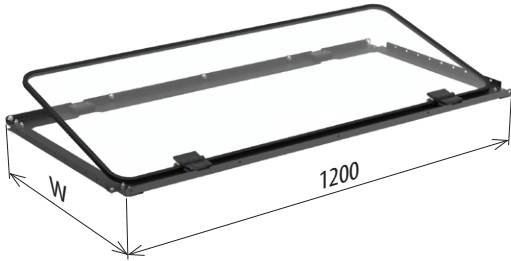

## Cold aisle flat roof

Flat roof module for 1200 mm wide cold aisle. The transparent part of the module is tiltable. The modular design allows easy expansion and installation of lighting.

### Material

Transparent plastic (polycarbonate); sheet steel powder painted in light grey (RAL 7035) or black (RAL 9005).

### Scope of delivery

Roof module with fixing accessories.

Width W [mm]	Catalogue number	
	RAL 7035	RAL 9005
300	W-8848-60-04-011	W-8848-60-04-161
400	W-8848-60-05-011	W-8848-60-05-161
600	W-8848-60-02-011	W-8848-60-02-161
800	W-8848-60-01-011	W-8848-60-01-161

Package: 1 pc.

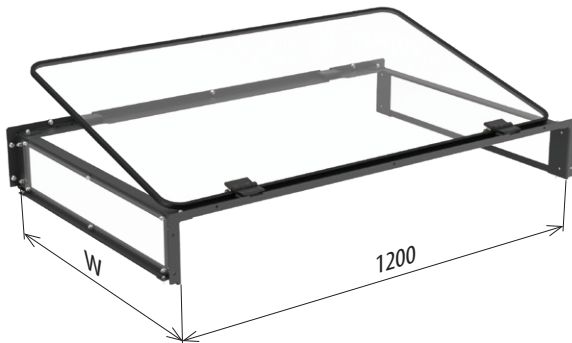

## Cold aisle raised roof

Roof module with internal height of 150 mm for 1200 mm wide cold aisle. The top transparent element of the module is tiltable. The modular design allows easy expansion and installation of lighting.

### Material

Transparent plastic (polycarbonate); sheet steel powder painted in light grey (RAL 7035) or black (RAL 9005).

### Scope of delivery

Roof module with fixing accessories.

Width W [mm]	Catalogue number	
	RAL 7035	RAL 9005
300	W-8848-40-04-011	W-8848-40-04-161
400	W-8848-40-05-011	W-8848-40-05-161
600	W-8848-40-02-011	W-8848-40-02-161
800	W-8848-40-01-011	W-8848-40-01-161

Package: 1 pc.

SERVER CABINETS **SZB/DSR IT 19"**

COLD AISLE INSTALLATIONS

**Partition panel for cabinets baying in row**

Side panel of the cabinet adapted as partition between cabinets baying in row. It is with four openings for clamp connectors bolts.

**Material**

Sheet steel powder painted in light grey (RAL 7035) or black (RAL 9005).

**Scope of delivery**

One-piece or two-piece complete partition panel with locks, fixing pins and an earthing conductor.

For cabinets'		Catalogue number	
height	depth	RAL 7035	RAL 9005
42 U	1200	W-8848-24-4210-011	W-8848-24-4210-161
	1000	W-8848-24-4212-011	W-8848-24-4212-161
47 U	1200	W-8848-24-4710-011	W-8848-24-4710-161
	1000	W-8848-24-4712-011	W-8848-24-4712-161

Package: 1 pc.



**W-8848-24-4712-161**  
Two-parts partition panel  
for cabinet SZBIT 47 U , 1200 mm deep

**W-8848-24-4210-161**  
Partition panel  
for SZB IT 42 U, 1000 mm deep

**Set for baying SZB IT cabinets in rows**

Set of elements for baying SZB IT cabinets.  
One set is intended for baying two cabinets.

**Material**

Al-Zn coated sheet steel.

**Scope of delivery**

4 clamp connectors, 4 bolts M8 with nut.

Package	Catalogue number
1 set	W-8848-23-00-000



Baying frame posts  
without partition panel



Baying frame posts  
with partition panel



# SZB/DSR IT 19" SERVER CABINETS

COLD AISLE INSTALLATIONS



**W-8848-50-06-161**  
Cold aisle cover for Data Box set 47 U with feet and raised roof

## Cold aisle cover

It is an optional solution instead of sliding doors. Designed for cold aisle **1200 mm** wide.

### Material

Sheet steel powder painted in light grey (RAL 7035) or black (RAL 9005).

### Scope of delivery

Cold aisle cover, aisle roof masking panel, sealing (for set on feet only), fixing accessories.



**Data Box set 47 U with feet, raised roof and cold aisle cover**

For Data Box with cabinets' height	Catalogue number			
	Cover for aisle with raised roof		Cover for aisle with flat roof	
	RAL 7035	RAL 9005	RAL 7035	RAL 9005
42 U without feet or plinth	W-8848-50-01-011	W-8848-50-01-161	W-8848-50-10-011	W-8848-50-10-161
47 U without feet or plinth	W-8848-50-03-011	W-8848-50-03-161	W-8848-50-12-011	W-8848-50-12-161
42 U with feet	W-8848-50-04-011	W-8848-50-04-161	W-8848-50-13-011	W-8848-50-13-161
47 U with feet	W-8848-50-06-011	W-8848-50-06-161	W-8848-50-15-011	W-8848-50-15-161
42 U with plinth	W-8848-50-07-011	W-8848-50-07-161	W-8848-50-16-011	W-8848-50-16-161
47 U with plinth	W-8848-50-09-011	W-8848-50-09-161	W-8848-50-18-011	W-8848-50-18-161

Package: 1 set

# SERVER CABINETS SZB/DSR IT 19"

COLD AISLE INSTALLATIONS

### Sealing masking strip for cabinet on feet

Sealing masking strip protects from getting cold air from the aisle to the space under the cabinet.

**Material**

Sheet steel powder painted in light grey (RAL 7035) or black (RAL 9005), black plastic.

**Scope of delivery**

Sealing masking strip with fixing accessories.

For cabinets' width [mm]	Catalogue number	
	RAL 7035	RAL 9005
800	W-8848-27-02-011	W-8848-27-02-161
600	W-8848-27-01-011	W-8848-27-01-161

Package: 1 pc

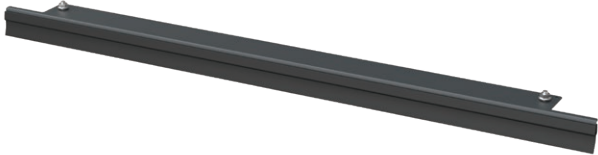

Cabinet equipped with sealing masking strip

### Aisle lightening

Aisle can be equipped with modular lightening. Available on request.

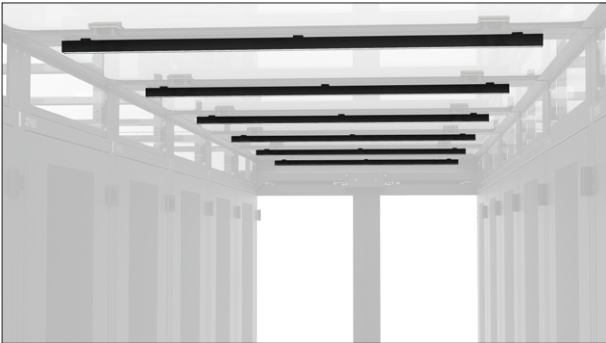
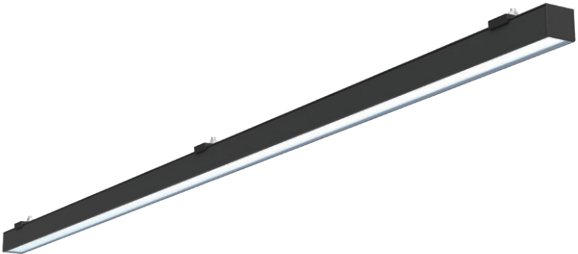

Example of light fittings mounted under the roof of the aisle

### Cable trays systems

Data Box set can be equipped with cable trays system assembled on cabinets. Available on request.

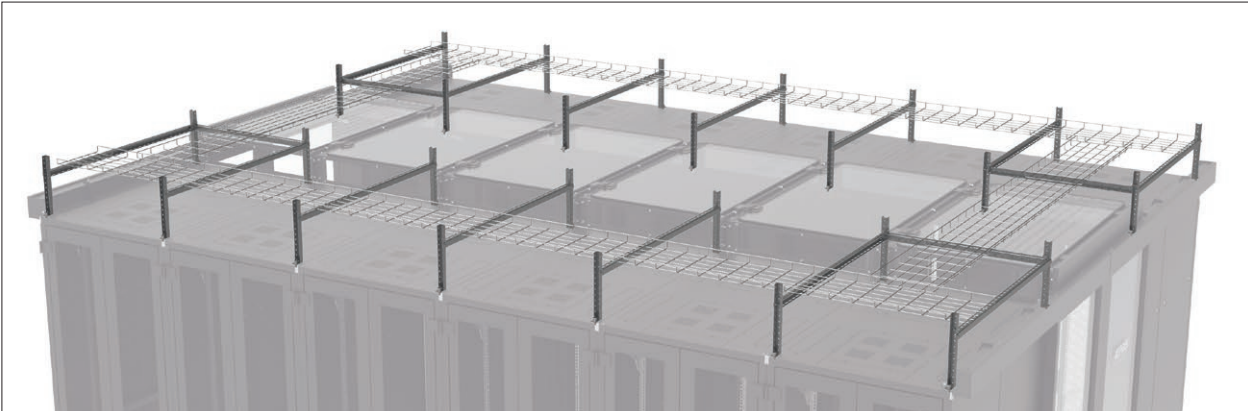

# SZB/DSR IT 19" SERVER CABINETS

COLD AISLE INSTALLATIONS – EXAMPLE OF CUSTOMISED VERSION



**Self-supporting structure. Cold aisle roof based on add-on cabinets, server cabinets can be replaced at any time.**



SERVER CABINETS **SZB/DSR IT 19"**

COLD AISLE INSTALLATIONS – EXAMPLE OF CUSTOMISED VERSION

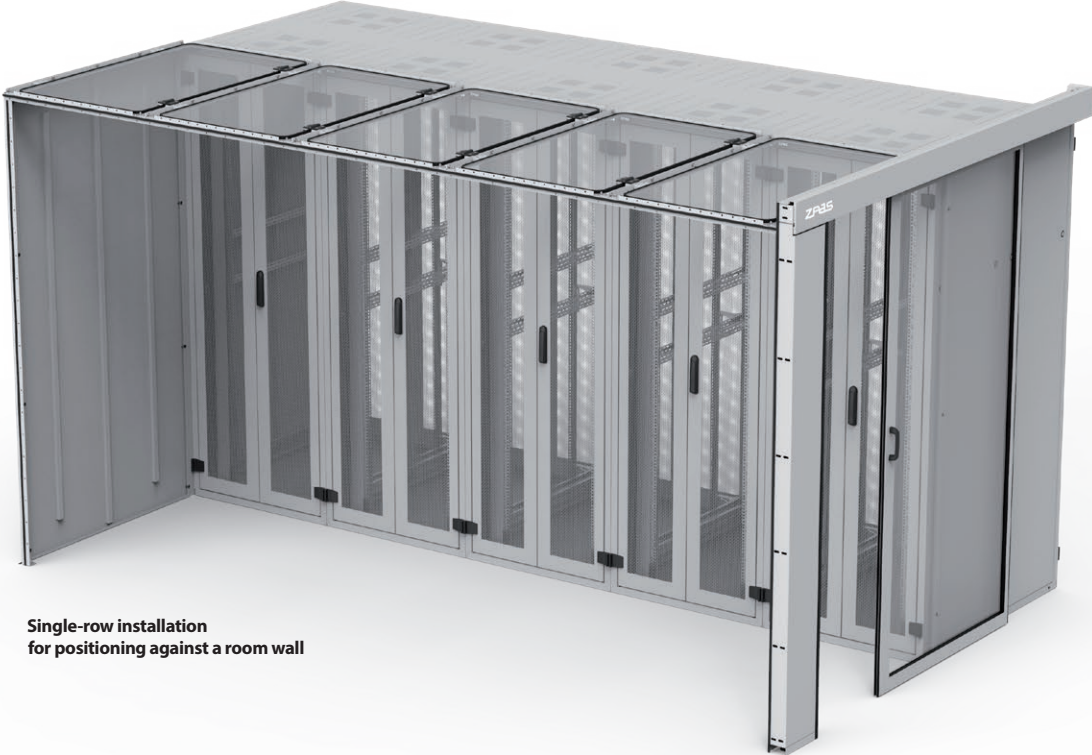

Single-row installation for positioning against a room wall



Cold aisle installation consisting of cabinets of different depths